

INDEX

Item	Page no.
OVERVIEW	
Engine maintenance	7
Fuel tank door release and cap	6
Hood release	7
Indicator symbols	4-5
Instrument cluster	4
Instrument panel	2-3
Keyless entry²	6
FEATURES/OPERATIONS	
Air Conditioning/Heating	17
Audio	18-19
Auto lock functions^{1, 2}	8
Auto LSD (Limited Slip Differential)	21
Automatic Transmission	8
Bottle holders	23
Clock	13
Cruise control	16
Cup holders	22
Door locks	20
Four-wheel drive	9
Garage door opener (HomeLink [®]) ³	21
Light control-Instrument panel	13
Lights² & turn signals	14
Moonroof²	22
Parking brake	11
Power outlets	23
Rear seat entertainment system	20
Seat adjustments-Front	10
Seat adjustments-Rear	12
Seat heaters	16
Seats-Head restraints	11
Tilt and telescopic steering wheel	10
Windows²	15
Window-Rear hatch²	15
Windshield wiper & washer	13
SAFETY AND EMERGENCY FEATURES	
Doors-Child safety locks	24
Seat belts	24
Seat belts-Shoulder belt anchor	24
Spare tire & tools	25
Tire Pressure Warning System	24

¹ Programmable by customer. Refer to the Owner's Manual for instructions and more information.

² Visit your Toyota dealer for information on customizing this feature.

³ HomeLink[®] is a registered trademark of Johnson Controls, Inc.

OVERVIEW

FEATURES/OPERATIONS

SAFETY AND EMERGENCY FEATURES

OVERVIEW

Instrument panel

Steering wheel switches (if equipped)

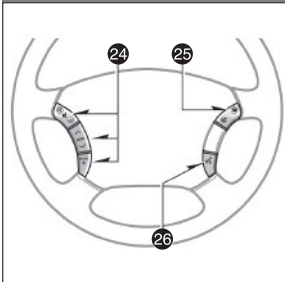

Rear console box

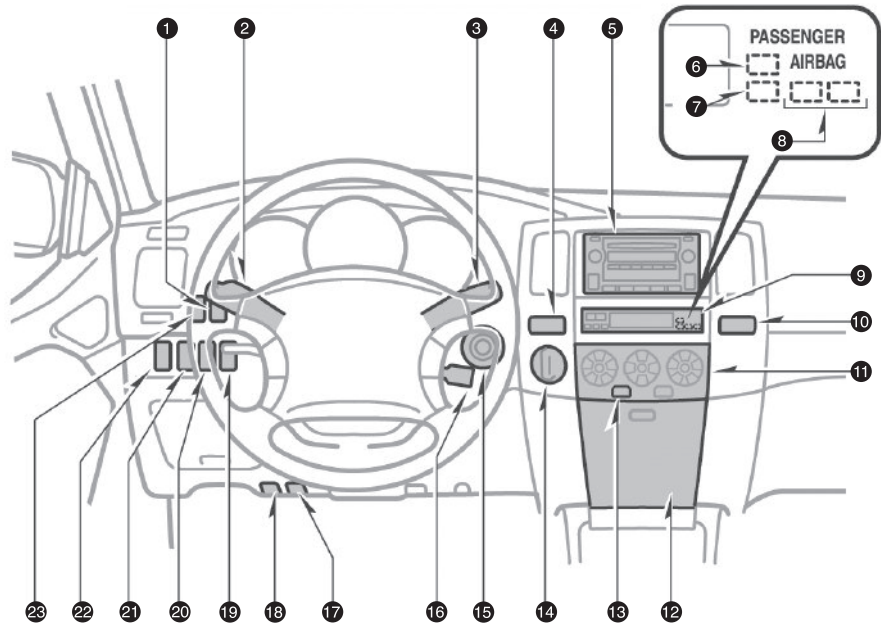
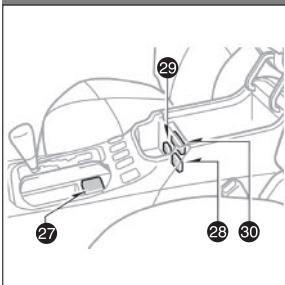

- ❶ Driving position memory switches¹
- ❷ Headlight, turn signal and front fog light¹ control
- ❸ Wiper and washer controls
- ❹ Power back window switch
- ❺ Audio system or navigation system^{1,2}
- ❻ Front passenger seat belt reminder light
- ❼ Engine immobilizer/Theft deterrent system indicator¹
- ❽ Front passenger occupant classification indicator
- ❾ Multi-information display
- ❿ Emergency flasher switch
- ⓫ Air Conditioning controls
- ⓬ Auxiliary boxes
- ⓭ Back window and outside rear view mirror defogger¹ switch
- ⓮ Four-wheel drive selector¹ (full-time 4WD models) or two wheel/four-wheel drive selector¹ (part-time 4WD models)
- ⓯ Ignition switch
- ⓰ Cruise control
- ⓱ Hood release
- ⓲ Fuel tank door opener
- ⓳ “RSCA OFF” (Roll Sensing of Curtain shield Airbags “OFF”) switch¹
- ⓴ “AUTO LSD” switch¹
- ⓵ Center differential lock switch¹
- ⓶ 115V AC Power outlet ON/OFF switch¹
- ⓷ Instrument panel light control
- ⓸ Steering wheel audio controls^{1,2}
- ⓹ Telephone switches^{1,2}
- ⓺ Navigation voice command button^{1,2}
- ⓻ 12V DC Power outlet/Cigarette lighter
- ⓼ 115V AC Power outlet¹
- ⓽ AUX adapter
- ⓿ A/V input adapter¹

¹ If equipped

² For details, refer to the “Navigation System Owner’s Manual.”

Instrument cluster

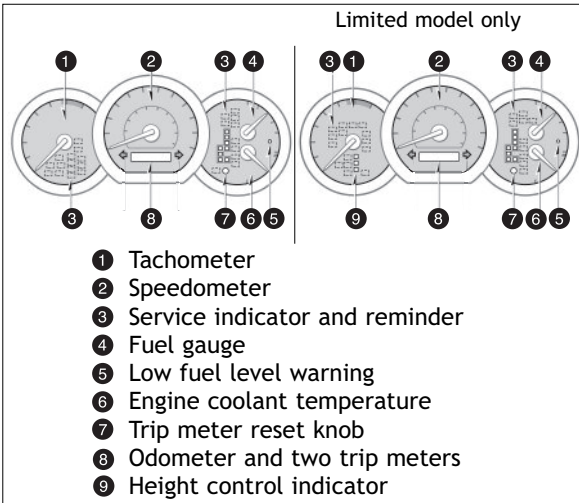

Indicator symbols

	Brake system warning ¹
	Driver/Front passenger seat belt reminder ¹
	Charging system warning ¹
	Low engine oil pressure warning ¹
	Malfunction/Check Engine indicator ¹
	Engine oil replacement reminder ¹
	<ul style="list-style-type: none"> • Vehicle Stability Control warning¹ • "AUTO LSD" warning¹ • Traction Control warning¹ • Downhill Assist Control warning¹ • Active Traction Control warning¹ • Hill-start Assist Control warning¹
	Open door warning ¹
	Airbag SRS warning ¹
	Low windshield washer fluid level warning ¹

¹ For details, refer to "Service reminder indicators and warning buzzers," Section 1-6, 2007 Owner's Manual.

² For details, see "Roll sensing of curtain shield airbags off switch," Section 1-3, 2007 Owner's Manual.

³ If this light flashes, refer to "Four-wheel drive system," Section

	Automatic Transmission fluid temperature warning ¹
	Low Tire Pressure Warning ¹
	Engine immobilizer/Theft deterrent system indicator
	Roll Sensing of Curtain shield Airbag "OFF" indicator ^{1,2}
	Front passenger occupant classification indicator
	Headlight high beam indicator
	Turn signal indicator
	Front fog light indicator
	Automatic Transmission indicator
	Low speed four-wheel drive indicator ³
	Center differential lock indicator ³
	Vehicle Stability Control "OFF" indicator
	Four-wheel drive indicator ³
	Slip indicator
	"AUTO LSD" indicator
	Downhill Assist Control indicator
	Height control indicator
	Height control "OFF" indicator ⁴
	Cruise control indicator ⁵
	Anti-lock Brake System warning ¹

CAUTION

When the Anti-lock Brake System (ABS) function is in action, you may feel the brake pedal pulsating and hear a noise. In this situation, to let the Anti-lock Brake System work for you, just hold the brake pedal down more firmly. Do not pump the brake as this will result in reduced braking performance.

1-7, 2007 Owner's Manual.

⁴ If this light flashes, refer to "Rear height control air suspension," Section 1-7, 2007 Owner's Manual.

⁵ If this light flashes, refer to "Cruise control," Section 1-7, 2007 Owner's Manual.

Fuel tank door release and cap

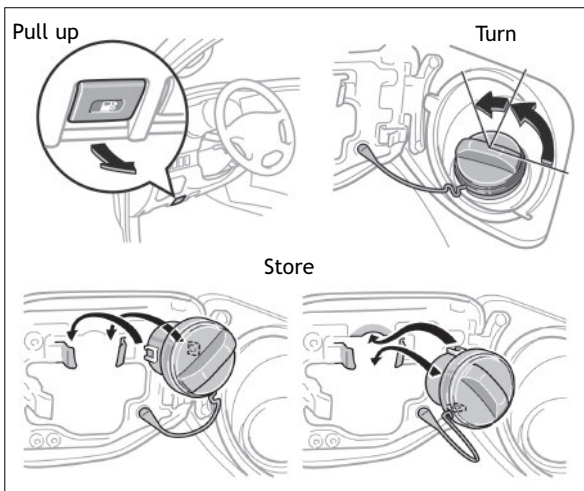

NOTE: Tighten until one click is heard. If the cap is not tightened enough, Check Engine “” indicator may illuminate.

Keyless entry (if equipped)

Beep sound can be switched “ON” or “OFF.” Refer to the *Owner’s Manual* for more details.

Locking operation

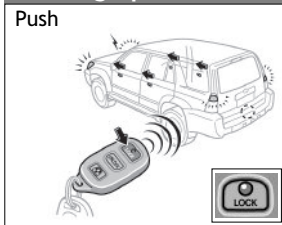

Unlocking operation



NOTE: After unlocking, if a door is not opened within 30 seconds, all doors will relock for safety.

Back window operation

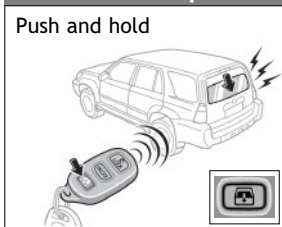

Alarm operation



Hood release

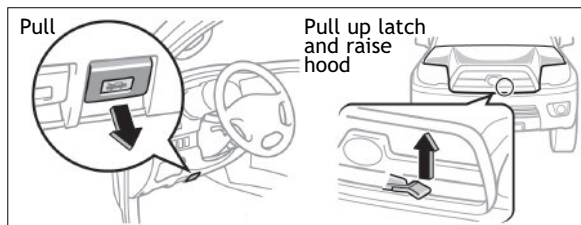

Engine maintenance

6 cylinder (1GR-FE) engine

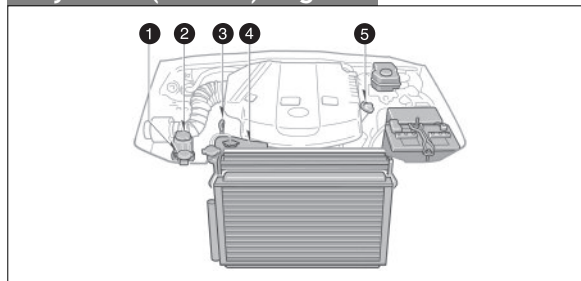

8 cylinder (2UZ-FE) engine

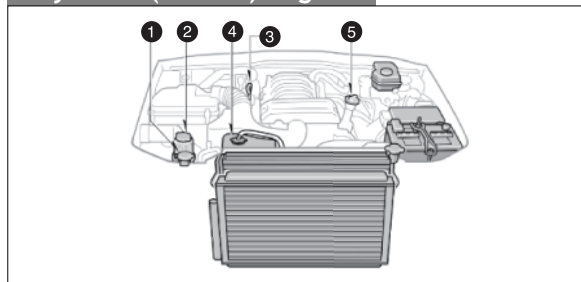

- ① Windshield and back window washer fluid tank
- ② Power steering fluid reservoir
- ③ Engine oil level dipstick
- ④ Engine coolant reservoir
- ⑤ Engine oil filler cap

Note: Regularly scheduled maintenance, including oil changes, will help extend the life of your vehicle and maintain performance. Please refer to the “Owner’s Warranty Information Booklet,” “Scheduled Maintenance Guide” or “Owner’s Manual Supplement.”

FEATURES/OPERATIONS

Auto lock functions

Automatic door locks can be programmed to operate in 4 different modes, or turned OFF.

- Doors lock when shifting from “Park.”
- Doors lock when the vehicle speed goes above approximately 12 mph.
- Doors unlock when shifting into “Park.”
- Doors unlock when the ignition switch is set from “ON” to “ACC” or “OFF” and driver’s door is opened.

Refer to the *Owner’s Manual* for more details.

Automatic Transmission

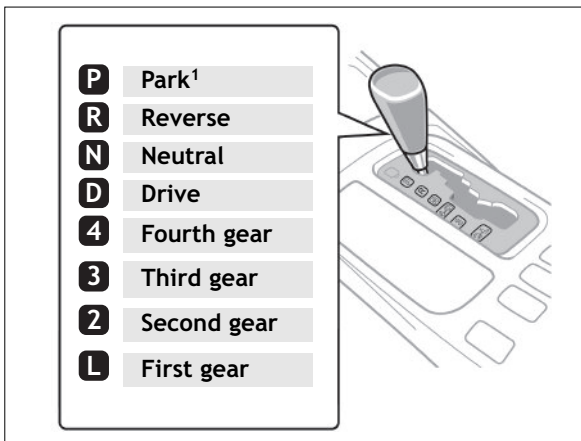

¹ The ignition switch must be ON, and the brake pedal depressed to shift from “Park.”

Downshifting increases power going uphill, or provides engine braking downhill. For best fuel economy during normal driving conditions, always drive with the shift lever in the “D” position.

Four-wheel drive (if equipped)

Part-time four-wheel drive models

- H2** High speed (2WD)
- H4** High speed (4WD)
Turn to “H4” with speed below 62 mph.
- L4** Low speed (4WD)
Shift to “N” position, then push and turn to “L4.”

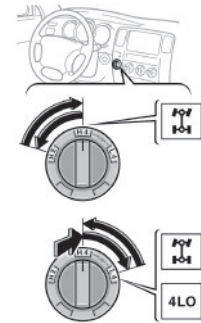

Full-time four-wheel drive models

- H4** High speed
Turn to “H4” with speed below 62 mph.
- L4** Low speed
Shift to “N” position, then push and turn to “L4.”

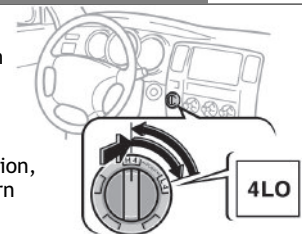

Center differential lock button

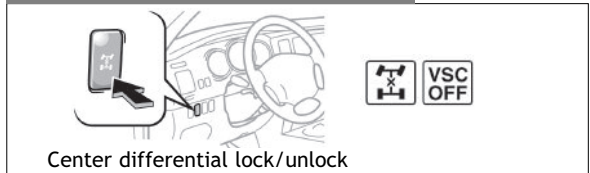

For best fuel economy and performance under normal driving conditions:

- “H2” position (part-time four-wheel drive models)
- “H4” position (full-time four-wheel drive models), Center differential unlocked (center differential lock indicator and “VSC OFF” indicator is not illuminated.)

Tilt and telescopic (if equipped) steering wheel

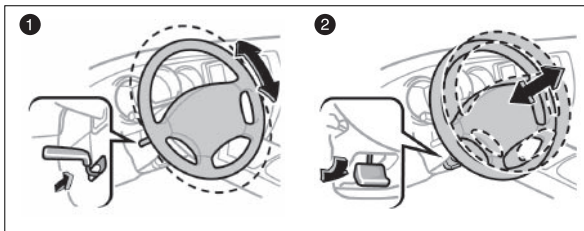

- 1 To change the angle Hold the steering wheel, pull the lock release lever, tilt to the desired angle, and release the lever.
- 2 To change the column length Push the lock release lever down, set the desired length, and return the lever to its locked position.

Note: Do not attempt to adjust while the vehicle is in motion.

Seat adjustments-Front

Manual seat

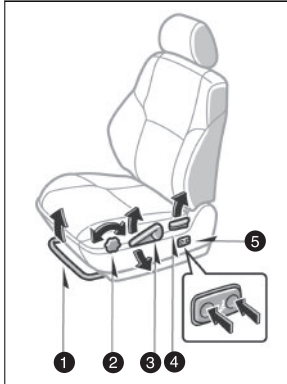

Power seat



- 1 Position
- 2 Cushion angle (driver side only)
- 3 Height crank (driver side only)
- 4 Seatback angle
- 5 Lumbar support (driver side only)
- 6 Driver seat: position, cushion angle and height
- 7 Passenger seat: position
- 8 Lumbar support (driver side only)

Seats-Head restraints

Front

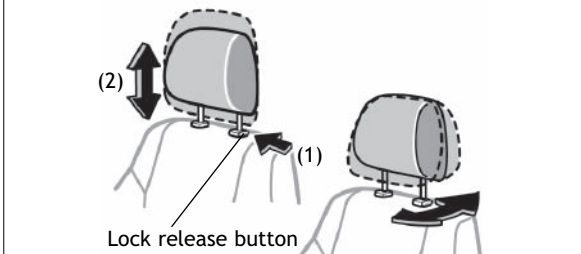

Second row seat

With third seat

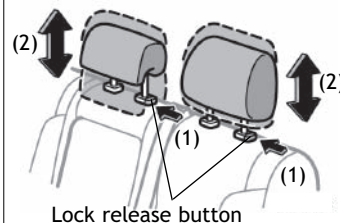

Without third seat

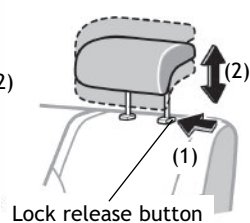

Third row

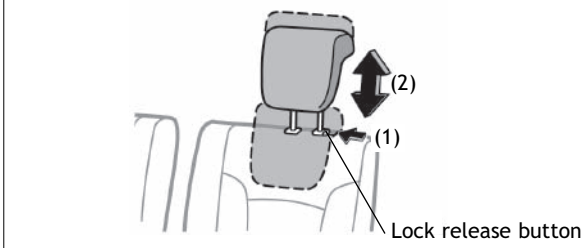

Parking brake

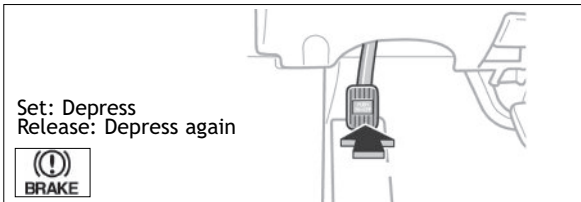

Seat adjustments-Rear (vehicles with third row seats)

Second row seats

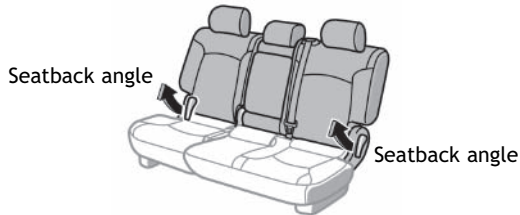

Third row seats



Seat adjustments-Rear (vehicles without third row seats)

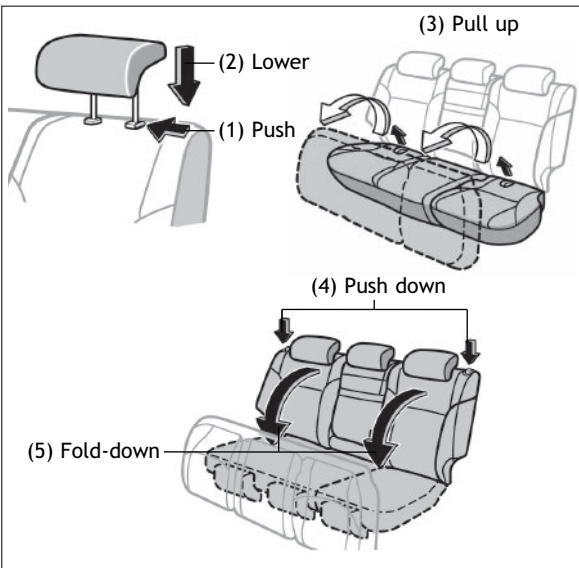

Windshield wiper & washer

Front

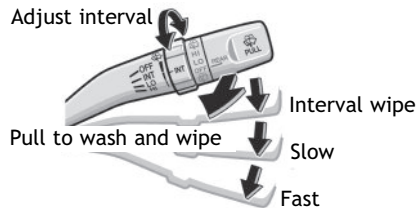

Rear

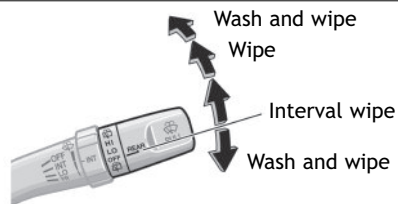

NOTE: Rear wiper and washer operate only when rear window is fully closed. If battery is disconnected, rear washer will not function until rear window is reinitialized by being fully opened and then closed.

Light control-Instrument panel

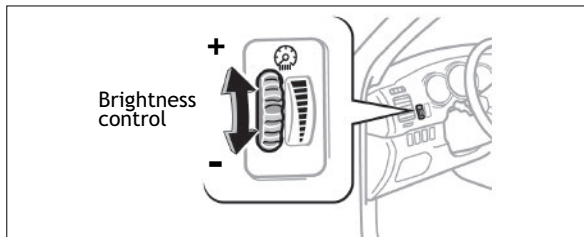

Clock

H- Hour set
M- Minute set
:00- Round off
minutes

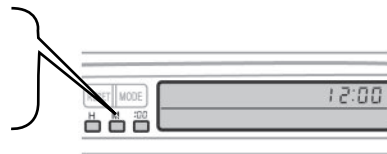

Lights & turn signals

Headlights

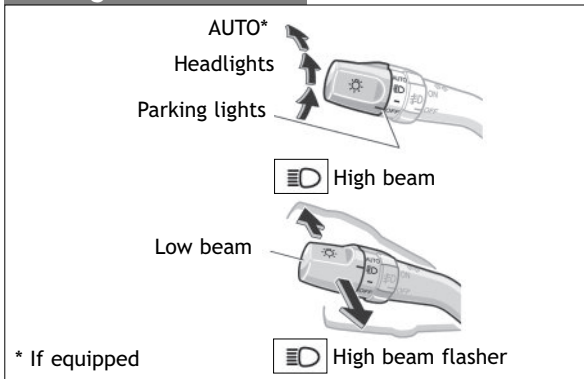

-Daytime Running Light system (if equipped)

Automatically turns on the headlights at a reduced intensity.

-Automatic light cut off system Will automatically turn lights off after a delay of 30 seconds, or the lock switch on remote may be pushed.

Turn signals

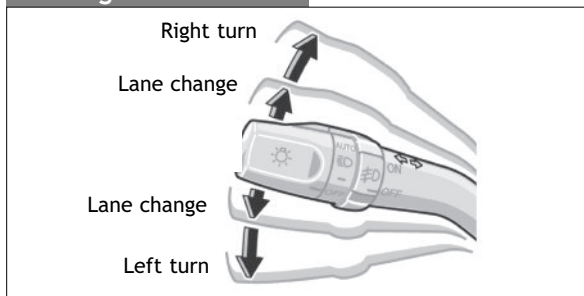

Front fog lights (if equipped)

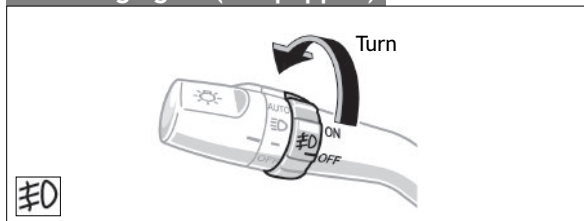

Front fog lights come on only when the headlights are on low beam.

Windows

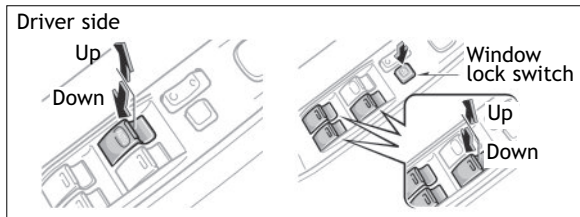

Automatic operation (driver side only) Push the switch completely down or pull it completely up and release to fully open or close. To stop window midway, lightly push the switch in the opposite direction.

Window lock switch Deactivates all passenger windows. Driver's window remains operable.

NOTE: If the battery is disconnected, the window will need to be reinitialized. Refer to the *Owner's Manual* for more details.

Window-Rear hatch

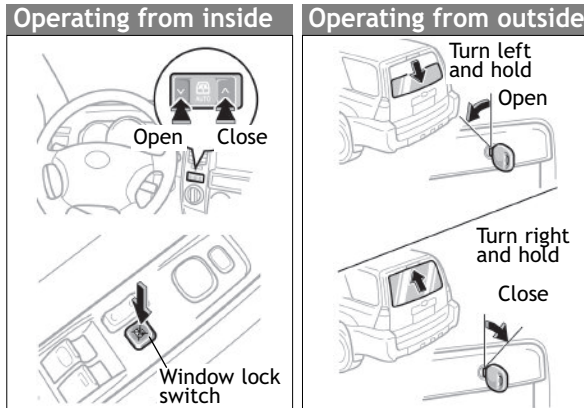

NOTE: If the battery is disconnected, the rear hatch window will need to be reinitialized. Refer to the *Owner's Manual* for more details.

Cruise control

Turning system ON/OFF

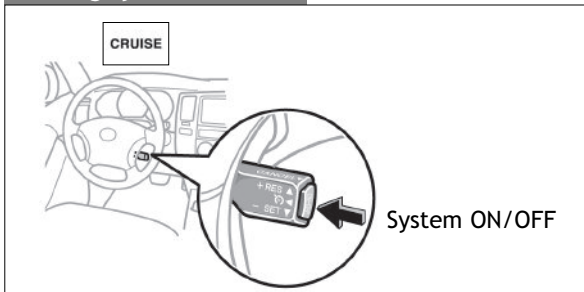

Functions

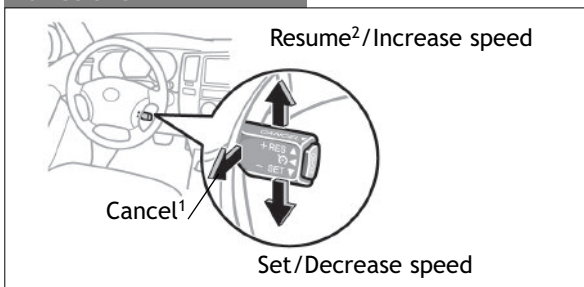

¹ The set speed may also be cancelled by depressing the brake pedal.

² The set speed may be resumed once vehicle speed exceeds 25 mph.

Refer to the *Owner's Manual* for more details.

Seat heaters

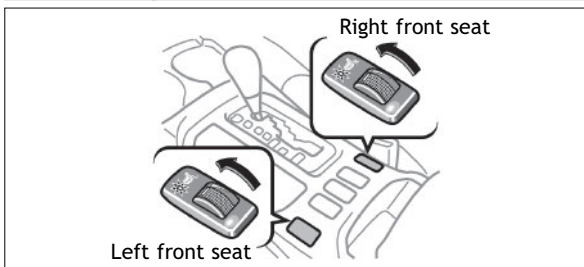

Air Conditioning/Heating

With "DUAL" button (if equipped)

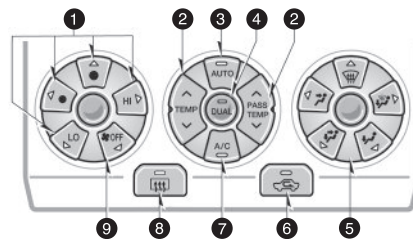

Without "DUAL" button

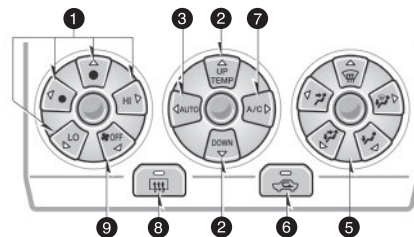

- 1 Fan speed
- 2 Temperature
- 3 Automatic climate control ON/OFF
- 4 "DUAL" button
Indicator ON: Separate temperature settings for driver and passenger.
Indicator OFF: Synchronize temperature settings for driver and passenger.
- 5 Air flow vent
 In "🌬️" or "🌬️" mode, use fresh air ("🚗" indicator "OFF") to reduce window fogging.
- 6 Fresh or recirculate cabin air
- 7 Air Conditioning ON/OFF
- 8 Rear defogger
- 9 Climate control OFF

Audio

Type 1 Preset buttons - functions in other modes indicated above number.

Eject CD
 Push to turn ON/OFF
 Seek station/CD track select
 Station/CD track scan
 Mode
 View radio/CD information
 Push to adjust tone & balance
 Push to skip up/down folder

Type 2 additional functions

Load CD(s)
 View genre/Push to skip up/down folder

Type 3 additional functions

AM/Satellite radio

CD PLAYER

To scan tracks on a disc Push “SCAN.” Push again to hold selection.

CD Changer (Type 2 and 3)

- To load one disc Push “LOAD” and insert one disc.
- To load multiple discs Push and hold “LOAD” until you hear a beep. Insert one disc. Shutter will close and then re-open for next disc.

To select a mode (MP3/WMA only) Turn “TUNE·FILE.”
 To select a folder (MP3/WMA only) Push either side of “FOLDER” or “TYPE/FOLDER.”

RADIO

To preset stations Tune in the desired station and hold down a preset button (1-6) until you hear a beep. Push desired preset button (1-6) to select.
 To scan stations Push “SCAN.” Push and hold to scan preset stations. Push again to hold selection.

Steering wheel controls (if equipped)

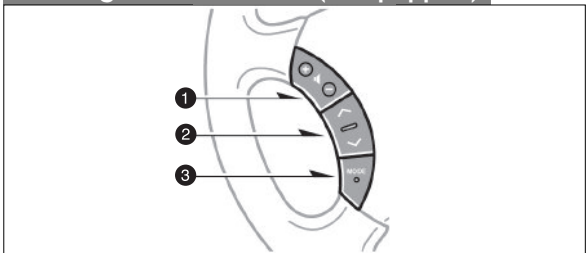

- 1 “- +”
Volume control
- 2 “^ v”
-In radio mode Push to select a preset station; push and hold to seek the next strong station.
-In CD mode Push to skip up or down to next/previous track.
- 3 “MODE”
Push to turn audio ON and select an audio mode. Push and hold to turn the audio system OFF.

AUX adapter

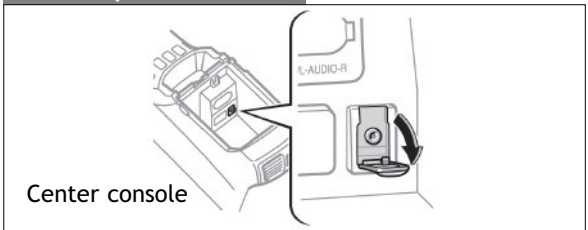

By inserting a mini plug into the AUX audio jack, you can listen to music from a portable audio device through the vehicle’s speaker system.

Door locks

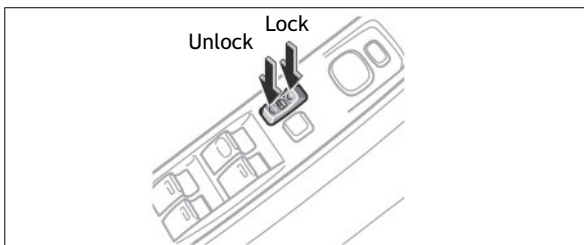

Rear seat entertainment system (if equipped)

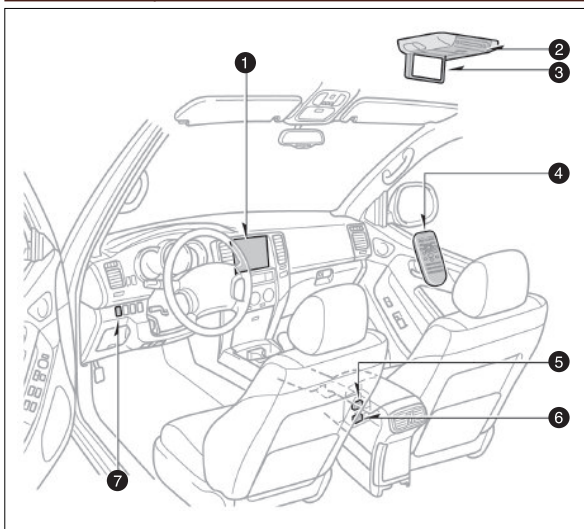

- 1 Front audio system
- 2 DVD player
- 3 DVD screen
- 4 Remote control
- 5 A/V input adapter
- 6 115V AC Power outlet
- 7 115V AC Power outlet ON/OFF switch

Garage door opener (HomeLink®)* (if equipped)

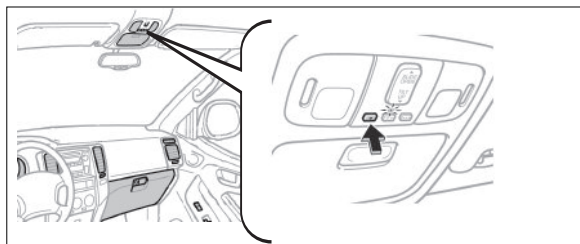

Garage door openers manufactured under license from HomeLink®* can be programmed to operate garage doors, estate gates, security lighting, etc.

Refer to the *Owner's Manual* for more details. For programming assistance, contact the Toyota Customer Experience Center at 1-800-331-4331, or visit <http://www.homelink.com>

* HomeLink® is a registered trademark of Johnson Controls, Inc.

Auto LSD (Limited Slip Differential) (if equipped)

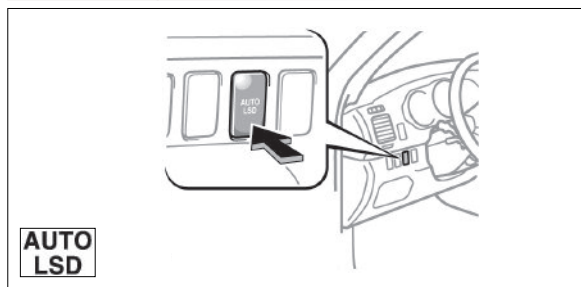

Push the "AUTO LSD" switch when the vehicle is stopped. To deactivate, push the switch again.

Note: Auto LSD will ONLY work in 2-wheel drive. It should ONLY be used when wheel spinning occurs on slippery or unpaved surfaces.

Refer to the *Owner's Manual* for more details on this system before attempting to use it.

Moonroof (if equipped)

Sliding operation

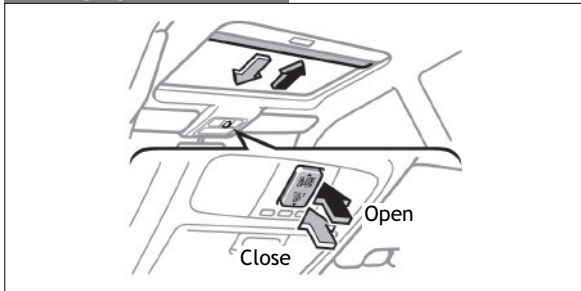

Tilting operation

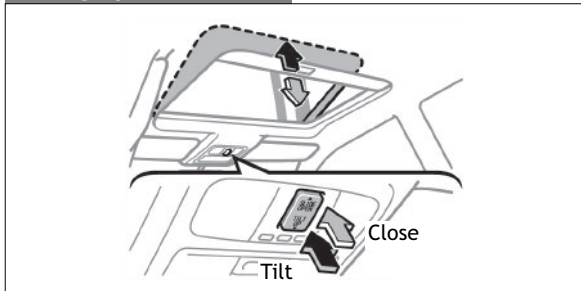

NOTE: If battery is disconnected, the moonroof will need to be reinitialized. Refer to the *Owner's Manual* for more details.

Cup holders

Center console

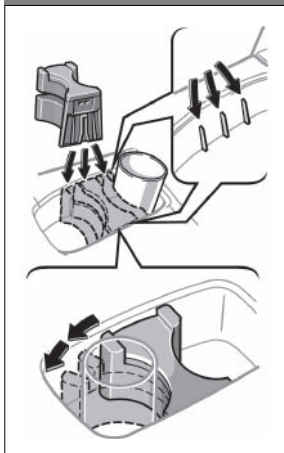

Rear

Second row seat

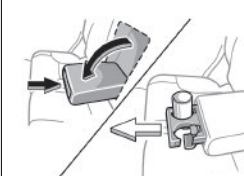

Third row side trim

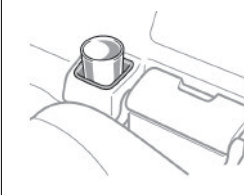

Bottle holders

Front doors

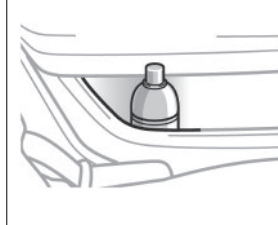

Rear doors

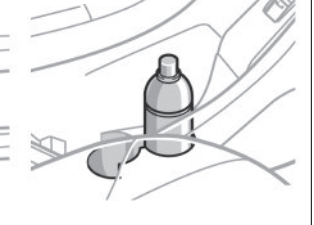

Power outlets

12V DC

Auxiliary box



Luggage compartment

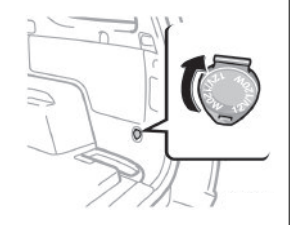

NOTE: Designed for car accessories. Key must be in the "ACC" or "ON" position to be used.

115V AC (if equipped)

ON/OFF switch

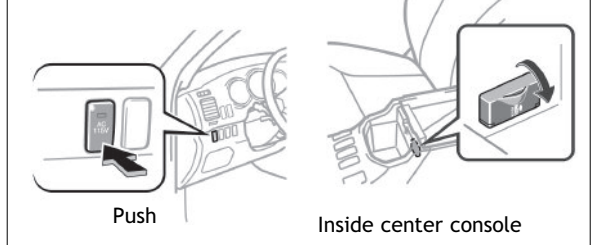

NOTE: Key must be in the "ON" position to be used.

SAFETY AND EMERGENCY FEATURES

Door-Child safety locks



Moving the lever to “LOCK” will allow the door to be opened only from the outside.

Seat belts

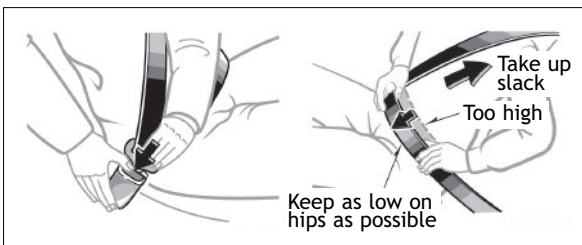

If belt is fully extended, then retracted even slightly, it cannot be re-extended beyond that point, unless fully retracted again. This feature is used to help hold child restraint systems securely.

To find more information about seat belts, and how to install a child restraint system, refer to the *Owner's Manual*.

Seat belts-Shoulder belt anchor

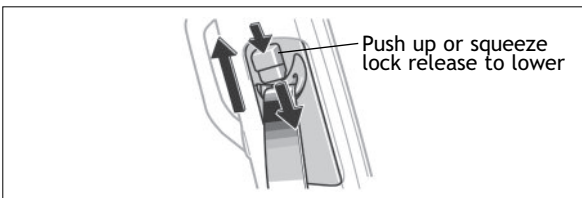

Tire Pressure Warning System

The system is designed to provide a warning “” when tire pressure of any one of the tires (including the spare) is reduced.

Refer to the *Owner's Manual* for more details.

